

**An Roinn Talmhaíochta,  
Bia agus Mara**  
Department of Agriculture,  
Food and the Marine



2003 Aquaculture and Foreshore Licence renewal application and an updated 2018 version which includes supplemental information. These applications should be read in tandem.



**AQUACULTURE - LICENSING UNDER**  
**FISHERIES (AMENDMENT) ACT, 1997**  
**FORESHORE ACT, 1933**

SHELLFISH AND FINFISH

*Aquaculture and Foreshore Licence Application Form*

**Important Note**

Section 4 of the Fisheries and Foreshore (Amendment) Act, 1998 (No. 54) prohibits any person making an application on or after 10 December 1998 for an Aquaculture Licence from commencing aquaculture operations until duly licensed under the Fisheries (Amendment) Act, 1997 (No. 23), and provides that a breach of that prohibition will cause the application to fail.

Coastal Zone Management Division  
Department of Communications, Marine and Natural Resources  
Leeson Lane, Dublin 2

Fax: (01) 6785868

**AQUACULTURE AND FORESHORE LICENCE APPLICATION FORM, for purposes of  
FISHERIES (AMENDMENT) ACT, 1997 and  
FORESHORE ACT, 1933**

Accompanying Guidance Notes should be read before completing this form.

**Note:** Details provided in Parts 1 and 2 will be made available for public inspection. Details provided in Part 3 are confidential and are not for public disclosure.

Use block capitals in black ink

*For Office Use*  
Application Ref. No. T5/317  
Date of receipt, [Dept stamp]:  
**26 NOV 2003**  
COASTAL ZONE MANAGEMENT DIV  
Department of Communications, Marine and Maritime Affairs

**PART 1: PRELIMINARY DETAILS**

Name(s) of Applicant(s) in full:  
1.A JOHN O'NEA ✓  
1.B  
Address(es) of Applicant(s) in full:  
1.A CLEANDARA  
ALDGLOOM  
BEARA  
CO LOKK  
1.B  
Tel.: [REDACTED] Tel.: Fax:

**1.C TYPE OF APPLICATION** Insert X in relevant box  
Indicate the relevant type of application:  
- (i) Aquaculture Licence   
- (ii) Trial Licence   
- (iii) Review of Aquaculture Licence   
- (iv) Renewal of Aquaculture Licence   
- (v) Foreshore Licence   
(This Application Form is valid for each type of application.)

**1.D TYPE OF AQUACULTURE**  
Indicate the relevant type of aquaculture:  
- (i) Land-based   
- (ii) Marine-based   
- Shellfish  
(iii) - extensive   
(iv) - intensive   
- (v) Finfish

**1.E DOCUMENTS ENCLOSED WITH THIS APPLICATION**

The following documents are enclosed with this application:

- (1) - Ordnance Survey Map (Scale of 1: 10,560, ie, a six inch map)
- (2) - British Admiralty Chart (largest available scale)
- (3) - Decision of planning authority under Planning Acts
- (4) - Copy of licence under Section 4 of Local Government  
Water Pollution) Act, 1977
- (5) - Environmental Impact Statement
- (6) - Drawing of the structures to be used and/or the layout of the farm
- (7) - Water Quality Analysis Report (required for Land-based sites only)
- (8) - Application Fee
- (9) - Other (specify):   
\_\_\_\_\_  
\_\_\_\_\_  
\_\_\_\_\_

**PART 2: DETAILS RELATING TO PROPOSED AQUACULTURE PROJECT**

**2.A Employment, Qualifications, Experience, etc.**

(i) Details of Applicant's qualifications and experience in aquaculture: *Fisherman over*  
*30 years involved in aquaculture 15-18 years.*

(ii) Other relevant experience (courses attended, etc.): *skippers ticket*  
*water safety first aid swimming*

(iii) Details of projected employment creation during first four years of proposed development:

(iv) Projected employment (number of persons):

Year 1:		Year 2:		Year 3:		Year 4:	
---------	--	---------	--	---------	--	---------	--

**2.B Aquaculture Site Details**

Indicate type of site:

- (i) land-based
- (ii) marine-based

<input type="checkbox"/>
<input checked="" type="checkbox"/>

**2.C Land-based Site**

(To be completed if appropriate)

(i) State species to be farmed: Mussels

(ii) State proposed system of culture e.g., pond, raceway, circular tank or other method: \_\_\_\_\_

(iii) Full address of proposed site including townland and County: Outer Harbour  
Adaprom Beara Co Cork.

(iv) Tonnage to be produced:

Year 1:		Year 2:		Year 3:		Year 4:	
---------	--	---------	--	---------	--	---------	--

(v) Proposed source of stock: Natural mussel seed.

(vi) Name of river(s) supplying site with water: \_\_\_\_\_

(vii) Estimate drought flow in gallons per minute: \_\_\_\_\_

(viii) Is there a fall of 1.5 metres in the water level at the site or can this be obtained by damming the river without giving rise to flooding of your own or neighbour's land upstream of the site? \_\_\_\_\_

(ix) Area of proposed site (hectares): Same

(x) Details of services available on the site e.g., main road access, electricity: \_\_\_\_\_

(xi) Are there at present any possible sources of pollution upstream of the site, e.g., discharge from sewerage plant, farmyard, sheep dip facility, silage effluent, quarry, sandpit or factory? YES  NO

(xii) If yes, supply details: \_\_\_\_\_

**Land-based Site (continued)**

2.D The following must be supplied:

- (i) Sketch of the layout of the site in relation to the river(s), road(s) and buildings;
- (ii) Water Quality Analysis Report, which should be drawn up in accordance with the parameters set out in Annex C of the Guidance Notes.

2.E The following conditions must be met in order to allow for consideration of licensing of land-based aquaculture:

- (i) the buildings and equipment must be put in place to the Department's satisfaction; and
- (ii) the operation must comply with Local Authority requirements.

**2.F Marine-based Site(s)**

(To be completed if appropriate)

Location - (i) Bay: Quilgloom Kenmare  
                  - (ii) County: Cork

(iii) OS Map No: 102  
(iv) Size (hectares): 8acre

(v) Species (to be specified):

- Aquatic Plant(s)
- Any form of aquatic food suitable for the nutrition of fish

(vi) Method of culture (e.g., nets, ropes, tanks, trestles etc.)

ropes & collectors

(vii) Drawings of structures to be used in method of culture should be enclosed.

(viii) If cages or tanks are proposed, state:

- (a) Number: \_\_\_\_\_
- (b) Type and shape: \_\_\_\_\_
- (c) Cubic capacity: \_\_\_\_\_
- (d) Depth: \_\_\_\_\_

(ix) Proposed specific site locations (with reasons): \_\_\_\_\_

(x) Describe proposed purification facilities to be used, where appropriate:

\_\_\_\_\_  
\_\_\_\_\_  
\_\_\_\_\_  
\_\_\_\_\_

**B. MARKETING (continued)**

Will the product be processed or packaged?

YES

NO

4. If yes, give details

---

---

---

---

---

I/We hereby declare the information provided in Parts 1, 2 and 3 above to be true to the best of my/our knowledge. I/We enclose an application fee\* of € 63.59 with this application.

Signature(s) of Applicant(s):

John O'Kea  
Clondara Aquaculture  
Beaumont Co. Cork

Date:

23/11/03

\* Preferred method of payment is by cheque or bank draft. The fee should be made payable to The Department of the Marine and Natural Resources.

This form should be forwarded, with the required documents and application fee, to:

Aquaculture Licensing  
Coastal Zone Administration Division  
Department of the Marine and Natural Resources  
Leeson Lane  
Dublin 2

**UPDATE/ADDITIONAL INFORMATION FORM**

**AQUACULTURE - LICENSING UNDER**  
**FISHERIES (AMENDMENT) ACT 1997 as amended**  
**and**  
**FORESHORE ACT 1933 as amended**

*Application Form for an Aquaculture and Foreshore Licence for  
a single specific site.*

*If a Licence is required for more than one site a separate  
application form must be completed for each site.*

**Important Note**

Section 4 of the Fisheries and Foreshore (Amendment) Act, 1998 (No. 54 of 1998) prohibits any person making an application for an Aquaculture Licence from commencing aquaculture operations until duly licensed under the Fisheries (Amendment) Act, 1997 (No. 23 of 1997), and provides that a breach of that prohibition will cause the application to fail.

A copy of an Environmental Impact Statement and Natura Impact Statement should be enclosed, if required, with all new, review and renewal applications. See Guidance Notes Section 3.

Aquaculture & Foreshore Management Division,  
Department of Agriculture, Food and the Marine,  
National Seafood Centre,  
Clonakilty, Co. Cork  
Telephone: (023) 8859500  
Fax: (023) 8821782



AQUACULTURE AND FORESHORE LICENCE APPLICATION FORM, for purposes of

Contact in case of enquiries (if different from above)	
Contact Name	For Office Use
FISHERIES (AMENDMENT) ACT, 1997 and FORESHORE ACT, 1933	Application Ref. No. <u>T5/317</u>
<i>NB: The accompanying Guidance Notes should be read before completing this form.</i>	Date of Receipt (Dept. Stamp):

**Note:** Details provided in Parts 1 and 2 will be made available for public inspection. Details provided in Parts 3 and 4 and any other information supplied will not be released except as may be required by law, including the Freedom of Information Act 1997 as amended.

**USE BLOCK CAPITALS IN BLACK INK PLEASE**

Type of Applicant (tick one)	
Sole Trader	<input checked="" type="checkbox"/>
Partnership	<input type="checkbox"/>
Company	<input type="checkbox"/>
Co-Operative	<input type="checkbox"/>
Other      Please specify-	<input type="checkbox"/>

**PART 1: PRELIMINARY DETAILS**

<b>Applicant's Name(s)</b>	[REDACTED]
1. <u>JOHN O SMEA.</u>	
Address: <u>CLEANDARA. AADGROOM. BEARA. Co. Cork.</u>	
2.	
Address:	
3.	
Address:	
4.	
Address:	

Organisation Name (if applicable)	
Address	

**PART 1: PRELIMINARY DETAILS**

**TYPE OF APPLICATION** – please indicate relevant type of application  
 This Application Form is valid for each type of application - *See Guidance Note 3.1*

(i) Aquaculture Licence	<input type="checkbox"/>
(ii) Trial Licence	<input type="checkbox"/>
(iii) Foreshore Licence, if Marine Based	<input type="checkbox"/>
(iv) Review of Aquaculture Licence	<input type="checkbox"/>
(v) Renewal of Aquaculture Licence	<input checked="" type="checkbox"/>

**TYPE OF AQUACULTURE**

*See Guidance Note 3.2*

Indicate the relevant type of application with a tick.

(i) **MARINE-BASED**

- |  |                                     |                          |
|--|-------------------------------------|--------------------------|
| Finfish                                  | <input type="checkbox"/>            | Go to Parts 2.1 and 2.1A |
| Shellfish <i>Subtidal</i>                | <input checked="" type="checkbox"/> | Go to Parts 2.2 and 2.2A |
| <i>Intertidal</i>                        | <input type="checkbox"/>            | Go to Parts 2.2 and 2.2A |
| Seaweed/Aquatic Plants/Aquatic Fish Food | <input type="checkbox"/>            | Go to Parts 2.3 and 2.3A |

(ii) **LAND-BASED**

- |                |                          |                   |                          |                          |
|----------------|--------------------------|-------------------|--------------------------|--------------------------|
| Finfish        | <input type="checkbox"/> | Shellfish         | <input type="checkbox"/> | Go to Parts 2.4 and 2.4A |
| Aquatic Plants | <input type="checkbox"/> | Aquatic Fish Food | <input type="checkbox"/> | Go to Parts 2.4 and 2.4A |

(iii) **TRIAL LICENCE**

- |                          |   |
|--------------------------|---|
| <input type="checkbox"/> | Go to appropriate Parts as above and to Part 2.5. |
|--------------------------|---|

**PART 2: DETAILS RELATING TO THE PROPOSED AQUACULTURE**

**PROJECT**

## 2.2 MARINE-BASED SHELLFISH AQUACULTURE

When filling out this section refer also to 2.2A and Guidance Note 3.3 for information on Conditions and Documents required with this application type

Proposed Site Location outer Redgloom Kenmore Bay Beera Co Cork

- (i) Bay: KENMAKE.
- (ii) County: CORK
- (iii) OS Map No: DISCOVERY 84.
- (iv) Co-ordinates of Site: (please specify coordinate reference system used e.g. Irish Grid (IG) or Irish Transverse Mercator (ITM) or Latitude/Longitude [in which case specify whether ETRS89 or WG84 etc.]  
\_\_\_\_\_  
\_\_\_\_\_  
\_\_\_\_\_
- (v) Size of Site (hectares): 317 A 4 HA.

(vi) Species (common and scientific name) and whether native or non-native species: (see Guidance Notes 3.3.1)

Native MUSSELS

(vii) Whether production will be sub-tidal or inter-tidal?  
\_\_\_\_\_

(viii) Please supply details of (a) source of seed e.g. wild hatchery and location and (b) means of collection and introduction to culture.

NATURAL SEED COLLECTION IF Bad COLLECTION

Rock seed is our only option

NB Importation of seed into the State or movement of seed within the State requires notification to the Marine Institute as per the Fish Health Authorisation Regulations - See Guidance Notes Section 6

(ix) Method of culture (rope, trestles - intensive; bottom - extensive; other) ROPE.

(x) Proposed number of lines/ropes/trestles as per site layout drawing  
\_\_\_\_\_

(xi) Proposed Production Tonnage:

Year 1	Year 2	Year 3	Year 4	Year 5
	60	60	80	80

(xii) (a) Please outline the reasons for site selection:

317 A Very EXPOSED HIGH Maintenance but good GROWTH and good depth.

(b) If using trestles please outline the physical characteristics of the site which make it suitable for using trestles

(xiii) Is it intended that the product is for direct human consumption or half grown? Please specify

MOSTLY FULLY GROWN FOR MARKET. SOME HALF-GROWN AND FEED SUPPLY TO OTHER FARMERS.

(xiv) How will the visual impact issues of the flotation devices for the proposed application be addressed?

USING GREY 50L PLASTIC BARRELS FOR LOW VISIBILITY

(xv) Is the site located in Designated Shellfish Waters Area? (Refer to Guidance Note 3.3.2)

Yes  No  MAP 2 SHELLFISH DESIGNATION KENMARE BAY.

If yes give details. SNEEM AND GROOM KILMACLOUGE.

If no outline the reasons why you believe the site suitable for the proposed aquaculture, notwithstanding its location outside Designated Shellfish Waters Area?

(xvi) Has the area been classified under Food Safety Legislation? (For Bivalve Molluscs) What is the current classification of the area for the proposed species applied for?

CLASS A.

(xvii) Is the site located in/adjacent to a sensitive area e.g. SPA (Special Protection Area) or SAC (Special Area of Conservation) i.e. a Natura 2000 site? (Refer to Guidance Note 3.3.1- Natura 2000 sites)

YES KENMARE BAY S.A.C.

(xviii) Are there known sources of pollution in the vicinity e.g. sewage outfall? Yes / No  
If yes please give full details.

No

(xix) Methods used to harvest the shellfish and details of any subsequent processing of shellfish GRADED AND WASHED WHILE HARVESTING  
TRAINED ON STRAND SOLD DIRECT TO BUYERS.

(xx) Describe any proposed purification facilities to be used:

(xxi) What are the main predators of the species to be cultivated?

Starfish

(xxii) Describe the method(s) which will be used to control them

Have to go through individual Droppers and  
lick the STARFISH off them if they SETTLE  
ON THEM.

See Part 2.2A for details of documentation to be included with this application type

## 2.2A DOCUMENTATION REQUIRED FOR MARINE-BASED SHELLFISH AQUACULTURE

(to be included separately with a Licence Application for a new site or for a renewal or review of an existing Licence)

1. **An appropriate Ordnance Survey Map (recommendation is a map to the Scale of 1:10,000/1:10,560, i.e. equivalent to a six inch map).** Note: The proposed access route to the site from the public road across tidal foreshore must also be shown on the map.
2. **Scale drawing of the structures to be used and the layout of the farm.**  
The proposed site drawings must illustrate all site structures above and below the water including mooring blocks. (recommended scales normally 1:100 for structures and 1:200 for layout ) (See Guidance Note 3.3.2)
3. **The prescribed application fee (See Guidance Note Section 4)**
4. **If the applicant is a limited Company within the meaning of the Companies Act 1963, as amended, the Certificate of Incorporation and Memorandum and Articles of Association**
5. **If the applicant is a Co-operative, the Certificate of Incorporation and Rules of the Co-operative Society**
6. **Environmental Impact Statement (if required) in certain cases- See Guidance Notes Section 3.3.1**
7. **Alien Species dossier ( where required) – See Guidance Notes Section 3.3.1**

**NOW COMPLETE PARTS 2.6, 3, 4 AND 5 PLEASE**

**2.6 Employment, Qualifications, Experience, etc  
TO BE FILLED IN BY ALL AQUACULTURE APPLICANTS**

(i) Please provide details of experience/qualifications of the applicant and any key personnel which are relevant to the aquaculture now proposed:

Fisherman for OVER 40 YEARS  
Aquaculture experience 25-30 YEARS.

(ii) If a new application please provide details of projected employment creation during first four years of the proposed aquaculture project:

(iii) In the case of a renewal please provide current and future details:

Mainly SELF OPERATED. occasional  
part time LABOURERS 2/3.

**FULLTIME JOBS**

Year 1:		Year 2:		Year 3:		Year 4:	
---------	--	---------	--	---------	--	---------	--

**PART TIME JOBS**

Year 1:		Year 2:		Year 3:		Year 4:	
---------	--	---------	--	---------	--	---------	--

CONFIDENTIAL

PART 3: APPLICANT DETAILS

PART 3 A. INDIVIDUAL(S)/SOLE TRADER(S)

(If necessary continue with extra page(s))

1. Name: JOHN O SHEA

Personal Public Service No. [REDACTED]

Date of Birth: [REDACTED]

Telephone No. [REDACTED]

Mobile No. \_\_\_\_\_

E-mail Address \_\_\_\_\_

2. Name: \_\_\_\_\_

Personal Public Service No. \_\_\_\_\_

Date of Birth: \_\_\_\_\_

Telephone No. \_\_\_\_\_

Mobile No. \_\_\_\_\_

E-mail Address \_\_\_\_\_

3. Name: \_\_\_\_\_

Personal Public Service No. \_\_\_\_\_

Date of Birth: \_\_\_\_\_

Telephone No. \_\_\_\_\_

Mobile No. \_\_\_\_\_

E-mail Address \_\_\_\_\_

4. Name: \_\_\_\_\_

Personal Public Service No. \_\_\_\_\_

Date of Birth: \_\_\_\_\_

Telephone No. \_\_\_\_\_

Mobile No. \_\_\_\_\_

E-mail Address \_\_\_\_\_

**PART 3E DETAILS FOR CONTACT IF DIFFERENT FROM APPLICANT(S)**

**Contact in case of enquiries**

Contact Name	
Organisation Name (if applicable)	
Address	
Telephone No.	
Mobile No.	
E-mail Address	

**CONFIDENTIAL**

**PART 4: FINANCE AND MARKETING**

**PART 4 A. FINANCE**

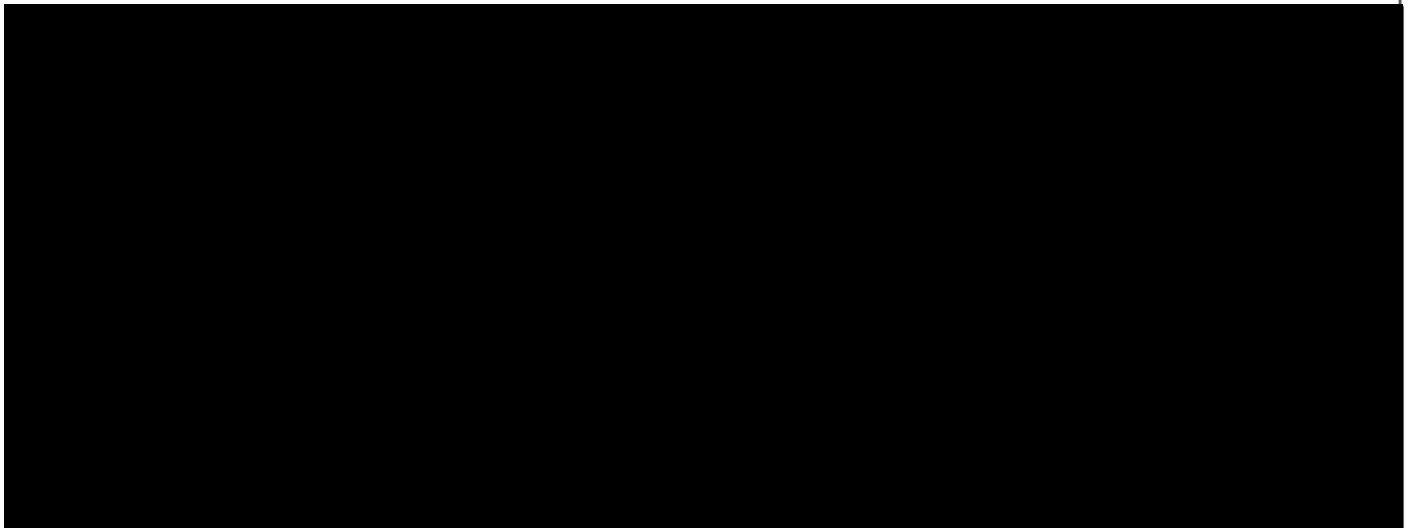

---

---

---

5. Do you intend to apply for grant aid or other funding from any State source (BIM, Udarás na Gaeltachta, FORFÁS, etc.)?

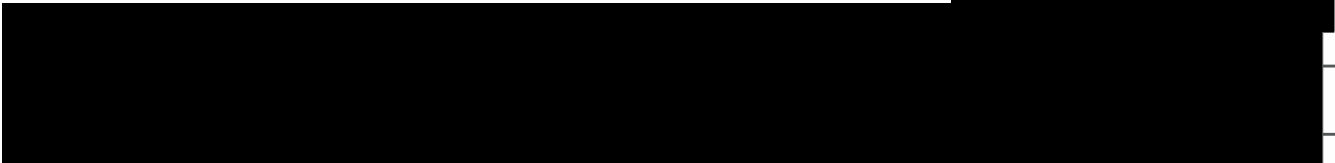

---

---



**7. Proposed capital costs of project, including navigation marks and lighting.**

Item	Cost €
[REDACTED]	
<b>Total:</b>	

**PART 4 A. FINANCE (continued)**

**8. Proposed non-capital costs of project (i.e. seed, feed, labour, etc.):**

Item	Cost €
<b>Total:</b>	

**9. Provide an estimate of the value of production over the first (next if renewal) four years based on projected annual production:**

[REDACTED]

**12. If this application relates to a new site, please set out below the projected production plan to full production by quantities on an annual basis showing stock inputs, growth and harvest production**

13. If this application relates to an existing site, please set out below the production by quantities on an annual basis for the last 4 years showing stock inputs, growth, survival rates and harvest production.



**CONFIDENTIAL**

**PART 4 B. MARKETING**



---

---

---

---

## PART 5: APPLICATION DOCUMENTATION

The following documents are enclosed with this application:

**NB: Refer to Guidance Note Section 3.3 – Guidance on Application Documentation**

No.	DOCUMENTATION	YES	NO	N/A
1a	<b>An appropriate Ordnance Survey Map (recommendation is a map to the scale of 1:10,000/10:10,560, i.e., equivalent to a six inch map)</b>			
1b	The proposed access route to the site from the public road across tidal foreshore must also be shown			
2a	<b>Scale drawing of the structures to be used (recommended scale normally 1:100 for structures).</b>			
2b	<b>Scale drawing of farm layout (recommended scale normally 1:200 for layout)</b>			
3	<b>The prescribed application fee</b>			
4	<b>Environmental Impact Statement (EIS), if required</b>			
4a	<b>Natura Impact Statement (NIS), if required</b>			
5	<b>Water Quality Analysis Report, if appropriate</b>			
6	<b>Decision of Planning Authority under the Planning Acts, if required</b>			
7	<b>Copy of Licence under Section 4 of the Local Government (Water Pollution) Act, 1977 – Effluent Discharge, if required</b>			
8	<b>If the applicant is a limited Company within the meaning of the Companies Act 1963, as amended, a copy of the Certificate of Incorporation and Memorandum and Articles of Association.</b>			
9	<b>If the applicant is a Co-operative, a copy of the Certificate of Incorporation and Rules of the Co-operative Society</b>			
10	<b>Integrated Pest Management Plan, if required</b>			
11	<b>Alien Species documentation, if required.</b>			

**PART 5: DECLARATION AND SIGNING**

**NB: Refer to Guidance Note Section 3.5 and Section 4 - Guidance on Declaration and Signing and Annual Aquaculture and Foreshore Licence Fees**

If this is a renewal/review have you met all licence conditions of the existing aquaculture licence? If applicable, explain why you have not complied with all conditions:

YES to the best of my ability

I/We hereby declare the information provided in Parts 1, 2, 3 and 4 above to be true to the best of my/our knowledge and that I am over 18 years of age. I/We enclose an application fee\* of € \_\_\_\_\_ with this application.

Signature(s) of Applicant(s):  
(Please state capacity of persons signing on behalf of a Company/Co-op)

John Sheehy  
Clear Lake Aquaculture  
Beana Co Coak

Date: 10/5/2018

**NB All persons named on this licence application must sign and date this application form. Only the existing licence holder(s) can apply for the renewal/review of an Aquaculture Licence.**

\*Preferred method of payment is by cheque or bank draft. The fee should be made payable to the Department of Agriculture, Food and the Marine.

**Refer to Guidance Note Section 4 - Guidance on Aquaculture and Foreshore Licence Fees**

The application form should be forwarded, with the required documents and application fee, to:

**Aquaculture Licensing  
Aquaculture & Foreshore Management Division  
Department of Agriculture, Food and the Marine  
National Seafood Centre  
Clonakilty  
Co. Cork**

**1 NO. SITE AT ARDGROOM HARBOUR CO.CORK**

**Co-ordinates & Area**

**Site T05/317A (4.0221 Ha)**

The area seaward of the high water mark and enclosed by a line drawn from Irish National Grid Reference point

070478, 058673 to Irish National Grid Reference point  
070579, 058774 to Irish National Grid Reference point  
070780, 058573 to Irish National Grid Reference point  
070676, 058475 to the first mentioned point.



70000

71000

59000

59000

T05/317A

Cornamullycree Island

Dog's Pt.

Ullinacree

58000

58000

PALLAS HARBOR

A R D G R C

H A R B O U R









70000

71000

**Aqua Culture Sites**

<all other values>

**Site\_Status**

-  Under Appeal
-  Application
-  Lapsed
-  Licensed
-  Refused
-  Revoked
-  Surrendered
-  Withdrawn
-  100 Meter Reference Grid

1:10,560

Sites highlighted in red denotes Application

Ordnance Survey Ireland Licence No. EN 0076418  
© Ordnance Survey Ireland/Government of Ireland



**An Roinn Talmhaíochta,  
Bia agus Mara**  
Department of Agriculture,  
Food and the Marine



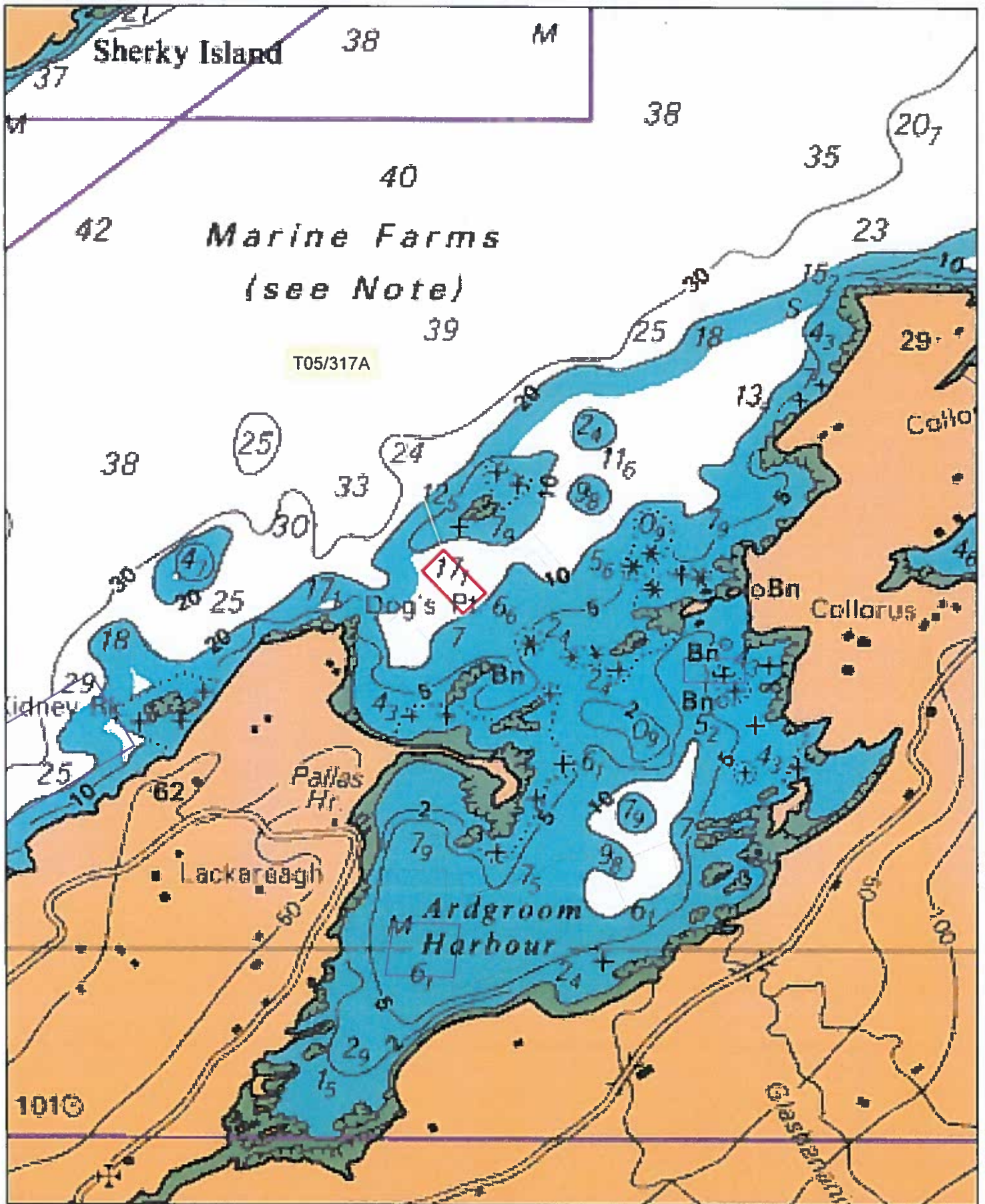

1:24,000

**Aqua Culture Sites**

<all other values>

**Site\_Status**

- Under Appeal
- Application
- Lapsed
- Licensed
- Refused
- Revoked
- Surrendered
- Withdrawn

Sites highlighted in red denotes Application

Part of Admiralty Chart No =2495-0  
Not to be used for Navigation



An Roinn Talmhaíochta,  
Bia agus Mara  
Department of Agriculture,  
Food and the Marine

**Legend**



Reconfigured Site Boundary



Longline



**T05/317A**  
4 Ha

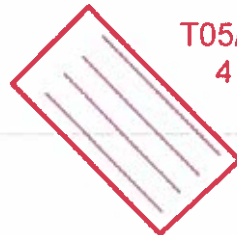

Ordnance Survey Ireland Licence No. EN 0076418  
© Ordnance Survey Ireland/Government of Ireland

Prepared by: R Scanlon, DAFM  
Date: 18/01/2019

Scale (@A4): 1:10,000

**Aquaculture Site Ref. T05/317A**  
**Site Location & Farm Layout**



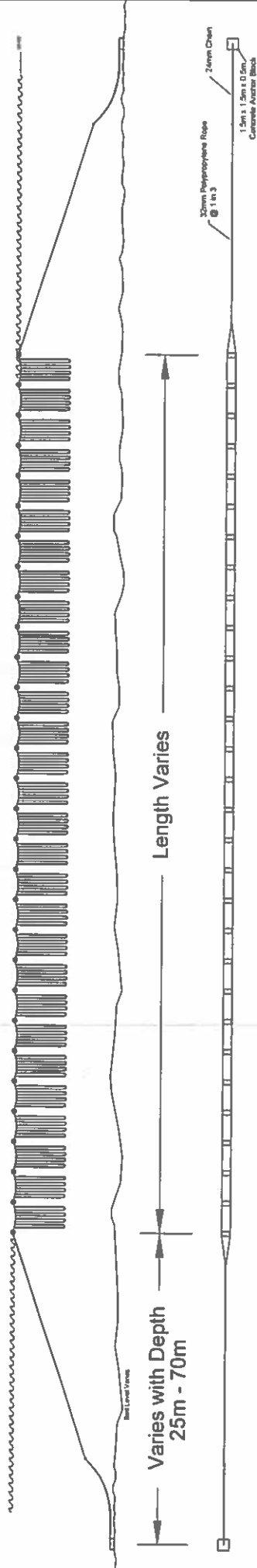

Typical Longline Section & Plan Detail  
Scale 1:500

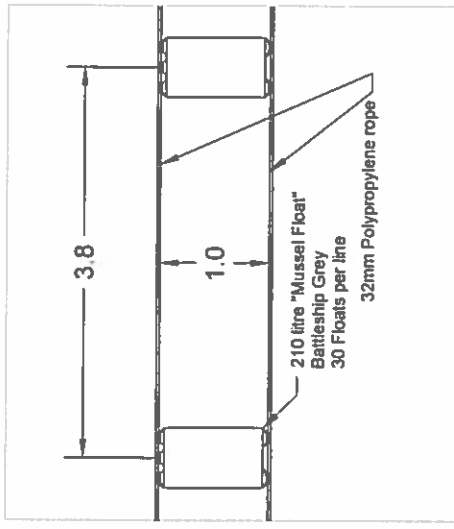

Typical Float & Rope Plan Detail  
Scale 1:50

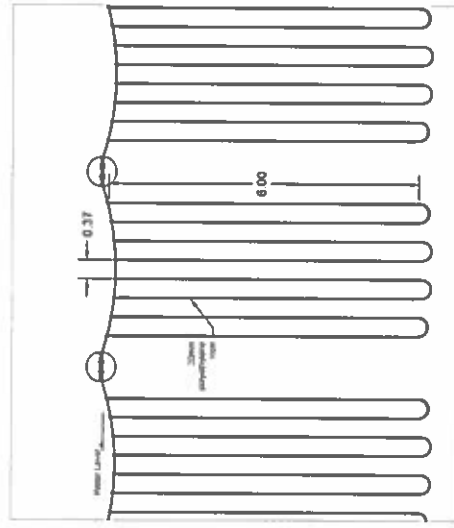

Typical Float & Rope Section Detail  
Scale 1:100

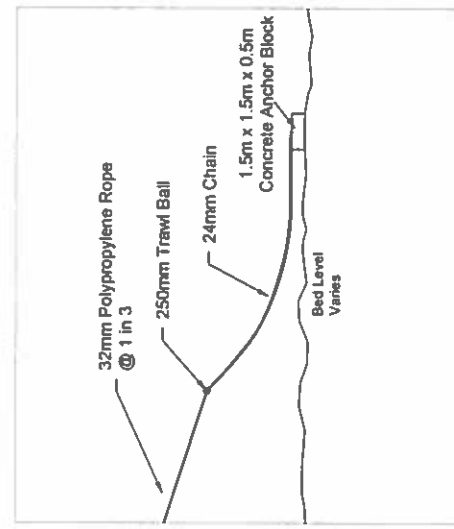

Typical Anchorage Section Detail  
Scale 1:200

Notes:	Project		Aquaculture Drawings		by		
	Mytilus Edulis		Description		ictid app		
The anchorage details shown are indicative only.	Title		Inshore Mussel Farm Longline Layout				
			Double Headrope Longline				
Scale		As Shown @ A3		Dwg. No.		Rev.	
Drawn		Jan 2019					
Checked							